



ART. 9701-W14

Piastrina angolare, Alluminio

Solar L Bracket, Aluminum

Codice Articolo Item Number	 Box	 Master carton	 Pallet
9701-W14	100	400	6000

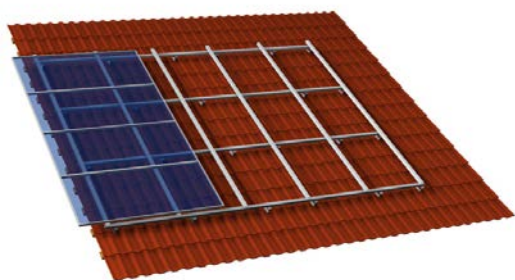
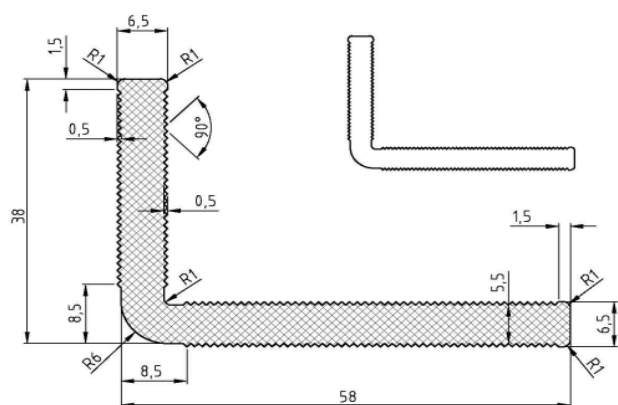

Per montare i pannelli senza cornice è necessario un sistema a guide incrociate. Il telaio così realizzato è particolarmente stabile. Si prega di osservare le istruzioni di montaggio del produttore dei pannelli fotovoltaici.

When you attach non-framed PV modules, you may have to conduct an assembly in the cross brace. This is a particularly stabile construction. You must always observe the module manufacturer instructions!

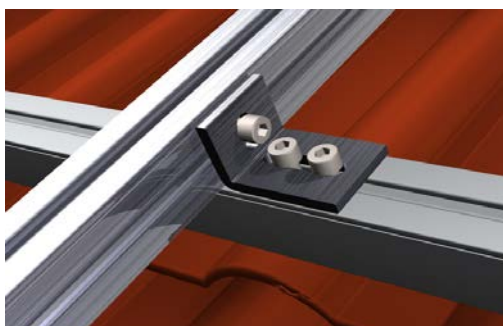

Giunzione dei due profilati con angolare di giunzione

Viti <i>Screws</i>	Din 912 M 8x16 x3	
Tassello scorrevole <i>Slot nut</i>	Art. 9431 x3	